

JBC

www.jbctools.com

INSTRUCTION MANUAL

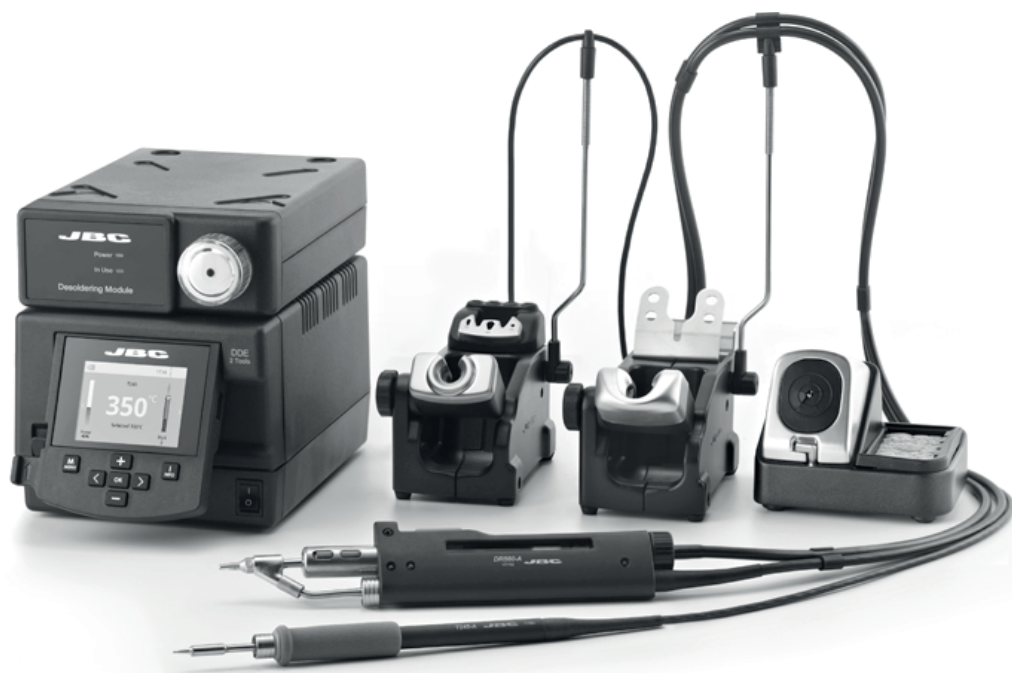

**Premium Rework station
with Electric Pump**

Ref. DDSE-C

Packing List

The following items should be included:

DDE Control Unit 1 unit
 Ref. DDE-1C (120V)
 DDE-2C (230V)
 DDE-9C (100V)



Electric Desoldering Module 1 unit
 Ref. MSE-A



ESD Tip Cleaner 1 unit
 Ref. CL8499



General Purpose Handle 1 unit
 Ref. T245-A



Stand 1 unit
 Ref. AD-SE



Desoldering Iron 1 unit
 Ref. DR560-A



Stand 1 unit
 Ref. DR-SE



Sponge 1 unit
 Ref. S0354



Metal Brush 1 unit
 Ref. CL6217



Brass Wool 1 unit
 Ref. CL6210



Stand Cable 2 units
 Ref. 0011283



Module Cable 1 unit
 Ref. 0014874



Power cord 1 unit
 Ref. 0010569 (230V)
 0013671 (100/120V)



Check our website for the corresponding manuals. Also available in other languages.

DR560 Accessories

Ref. 0010211

Tip cleaning set 1 unit
Ref. 0965970



Long Tip Cleaning set 1 unit
Ref. 0965760

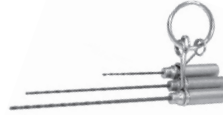

Tips 3 units
Ref. C560005 (x1)
C560013 (x1)
C560004 (x1)



Glass solder collector 1 unit
Ref. 0812620



Spanner 1 unit
Ref. 0780550



Filter Box 1 unit
Ref. 0780840
It contains 10 filters



Internal gasket 1 unit
Ref. 0019208
It contains 2 gaskets



Metal solder collector 1 unit
Ref. 0812630



Cartridges 2 units
Ref. C245903 (x1)
C245906 (x1)



Filter Box 1 unit
Ref. 0005966
It contains 50 filters



Cleaning stick 1 unit
Ref. 0786640



Union Flanges 1 unit
Ref. 0011356



Cotton Filter 1 unit
Ref. 0781046
It contains 10 filters



Suction Filter 1 unit
Ref. 0821830



Cartridge holder 1 unit
Ref. 0021083



Manual 1 unit
Ref. 0020487

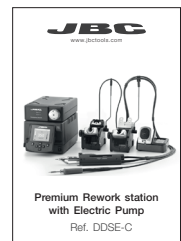

Features

Work simultaneously with **up to 2 tools** and join each station port with **1 module** + 1 pedal (Peripherals).

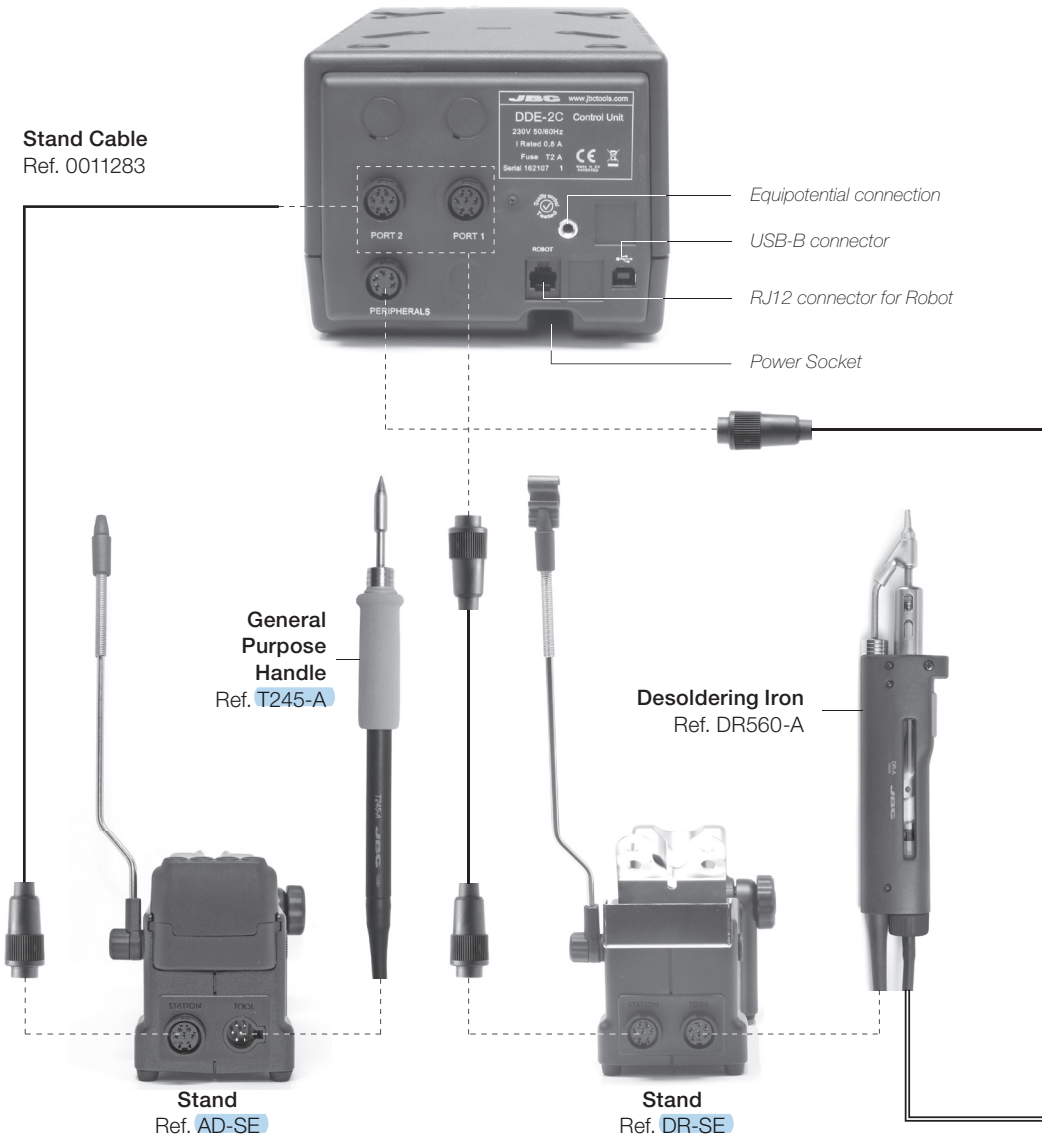

2,8" Color TFT screen

USB-A connector

Tilt the display
for easy reading

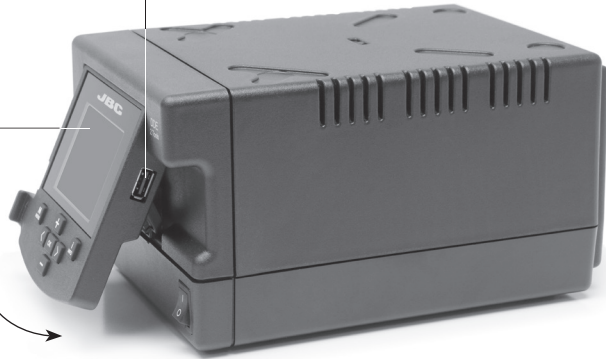

Module Cable
Ref. 0014874

Electric Desoldering Module
Ref. MSE-A

To another peripheral

To Pedal
Ref. P-005

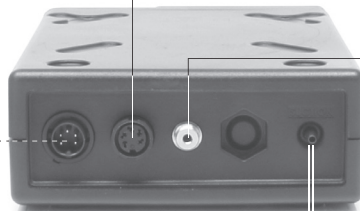

Suction Filter
Ref. 0821830



DDE-C Compatibility

Basic working system				Peripherals**			
Control Unit	Stand	Tool	Cartridge Range	MSE-A / MVE-A	MNE-A	FSE-A	P-005
DDE-C	AD-SE	T210-A	C210			●	●
		T245-A	C245			●	●
		T470-A	C245			●	●
	DN-SE	T210-NA*	C210		●		
		T245-NA*	C245				
		T470-NA*					
	AP-SE	AP250-A	C250			●	●
	PA-SE	PA120-A	C120			●	●
	HT-SE	HT420-A	C420			●	●
	DS-SE	DS360-A	C360	●			●
DR-SE	DR560-A	C560	●			●	

* The **MNE Nitrogen Flow Regulator** is required.

If you need to connect the **MS, MV, MN or **FS** modules, an adapter is required (Ref. IM2496).

MSE-A Compatibility

Module	Stand	Tool	Cartridge Range	Control Units		Peripherals
				DDE	DME	P-005
MSE-A	DS-SE	DS360-A	C360	●	●	●
	DR-SE	DR560-A	C560	●	●	●

Maintenance

Before carrying out maintenance or storage, always allow the equipment to cool.

- Clean the station screen with a glass cleaner or a damp cloth.
- Use a damp cloth to clean the casing and the tool. Alcohol can only be used to clean the metal parts.
- Periodically check that the metal parts of the tool and stand are clean so that the station can detect the tool status.
- Maintain tip surface clean and tinned prior to storage in order to avoid tip oxidation. Rusty and dirty surfaces reduce heat transfer to the solder joint.
- Periodically check all cables and tubes.



Clean periodically



- Replace a blown fuse as follows:

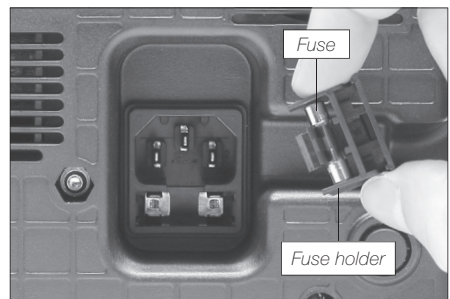
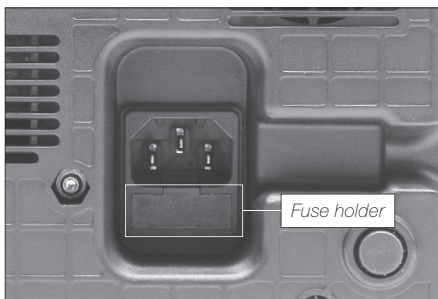

1. Pull off the fuse holder and remove the fuse. If necessary use a tool to lever it off.

2. Press the new fuse into the fuse holder and replace it in the station.

- Replace any defective or damaged pieces. Use original JBC spare parts only.
- Repairs should only be performed by a JBC authorized technical service.

Safety



It is imperative to follow safety guidelines to prevent electric shock, injury, fire or explosion.

- Do not use the units for any purpose other than soldering or rework. Incorrect use may cause fire.
- The power cord must be plugged into approved bases. Be sure that it is properly grounded before use. When unplugging it, hold the plug, not the wire.
- Do not work on electrically live parts.
- The tool should be placed in the stand when not in use in order to activate the sleep mode. The soldering tip, the metal part of the tool and the stand may still be hot even when the station is turned off. Handle with care, including when adjusting the stand position.
- Do not leave the appliance unattended when it is on.
- Do not cover the ventilation grills. Heat can cause inflammable products to ignite.
- Avoid flux coming into contact with skin or eyes to prevent irritation.
- Be careful with the fumes produced when soldering.
- Keep your workplace clean and tidy. Wear appropriate protective glasses and gloves when working to avoid personal harm.
- Utmost care must be taken with liquid tin waste which can cause burns.
- This appliance can be used by children over the age of eight and also persons with reduced physical, sensory or mental capabilities or lack of experience provided that they have been given adequate supervision or instruction concerning use of the appliance and understand the hazards involved. Children must not play with the appliance.
- Maintenance must not be carried out by children unless supervised.

有害物质含量表

产品中有害物质的名称及含量

部件名称	有害物质					
	铅(Pb)	汞(Hg)	镉(Cd)	六价铬 (Cr(VI))	多溴联苯 (PBB)	多溴二苯醚 (PBDE)
烙铁头	○	○	○	○	○	○
手柄	○	○	○	○	○	○
电源线	○	○	○	○	○	○
主机	○	○	○	○	○	○
电源插座	○	○	○	○	○	○
保险丝	○	○	○	○	○	○
主开关	○	○	○	○	○	○
电位连接	X	○	○	○	○	○
变压器	○	○	○	○	○	○
线路板	X	○	○	○	○	○

○ 表示该有害物质在该部件所有均质材料中的含量均在GB/T 26572 规定的限量要求以下。
X 表示该有害物质至少在该部件的某一均质材料中的含量超出GB/T 26572 规定的限量要求。

Specifications

Premium Rework Station with Electric Pump

DDSE-1C / DDSE-2C / DDSE-9C

- Total weight: 9,25 kg (20.4 lb)

DDE-1C 120V 50/60Hz. Input fuse: 4A. Output: 23.5V

DDE-2C 230V 50/60Hz. Input fuse: 2A. Output: 23.5V

DDE-9B 100V 50/60Hz. Input fuse: 5A. Output: 23.5V

- Net Weight: 3,815 kg (8.41 lb)
- Dimensions: 148 x 120 x 232 mm (5.83 x 4.72 x 9.13 in)
- Output Peak Power: 150W per tool
- Temperature Range: 90 - 450 °C (190 - 840 °F)
- Idle Temp. Stability (still air): ±1.5 °C (±3 °F)
- Tip to ground resistance: <2 ohms
- Tip to ground voltage: <2mV RMS
- Ambient Operating Temperature: 10 - 40 °C (50 - 104 °F)
- Communicatio connectors: USB-A / USB-B / Peripherals connectors
- Robot connector: RJ12 for RS-232 protocol

MSE-A

- Net Weight: 0,7 kg (1.54 lb)
- Dimensions: 145 x 55 x 225 mm (5.71 x 2.17 x 8.86 in)
- Air Pressure supply range: 4-6 Bar
- Vacuum at 6 Bar: 90% / 680 mmHg / 26.8 inHg
- Flow rate: 15 SLPM
- Ambient operating temp.: 10 - 40 °C (50 - 104 °F)
- Pedal connection

Complies with CE standards.
ESD protected.

Exploded View

DDSE-1C 120V
DDSE-2C 230V
DDSE-9C 100V

**REWORK STATION
 WITH ELECTRIC PUMP**

DDE-1C / DDE-2C / DDE-9C

SPARE PARTS	
DDE-1C / DDE-2C / DDE-9C:	
-REAR CIRCUIT	0018129
-ENCLOSURE	
· TOP	0019028
· BOTTOM	0014567
· FRONT+DISPLAY	0019246
· BACK	0013413
MSE-A:	
-CIRCUIT	0018453
-ENCLOSURE	
· TOP	0015266
· BOTTOM	0014010
· FRONT	0014688
· BACK	0015261
-PUMP	0005652

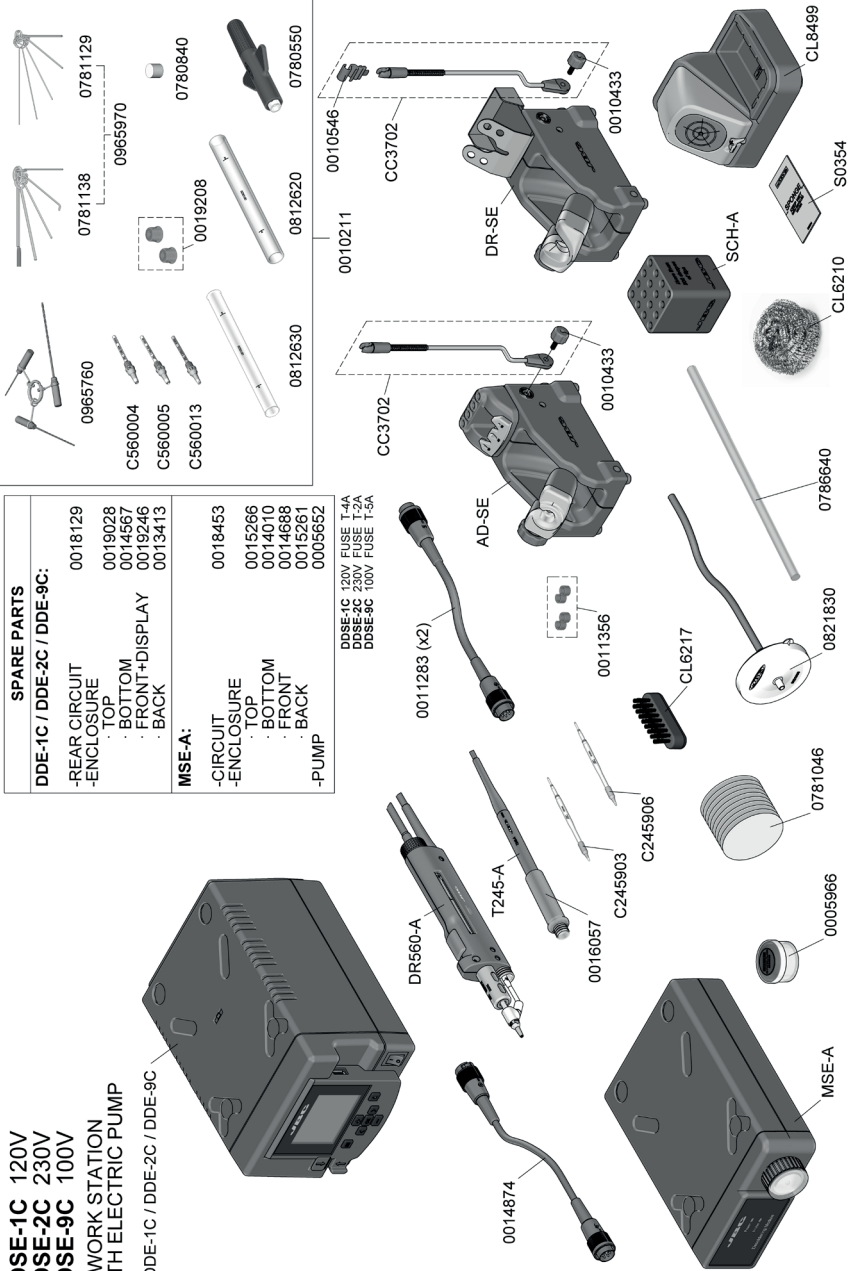

JBC

Warranty

JBC's 2 year warranty covers this equipment against all manufacturing defects, including the replacement of defective parts and labour. Warranty does not cover product wear or misuse. In order for the warranty to be valid, equipment must be returned, postage paid, to the dealer where it was purchased.

Please register your product warranty within 30 days of purchase in:
www.jbctools.com/productregistration.



This product should not be thrown in the garbage.
In accordance with the European directive 2002/96/EC, electronic equipment at the end of their life must be collected and returned to an authorized recycling facility.



Manual in other languages available on our website

www.jbctools.com